

Rectangle LOUVER Series

(基本長方形の形)- 기본 직사각형-내외장 벽, 천정

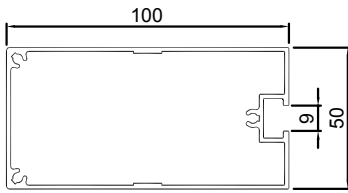

HM-054
1.44 kg/m
325.9mm

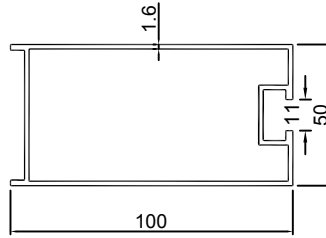

KU-276
1.417KG/M

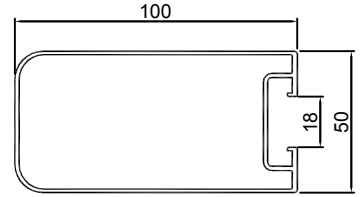

SKC-024
?: 1.165kg/m
????: 342 mm

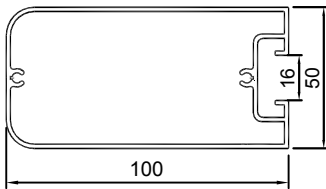

TKS-062-1
1.41 kg/m
347.6

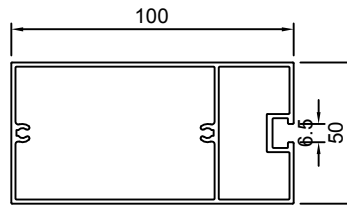

MR-001
1.579kg/m^{mm}
321.5

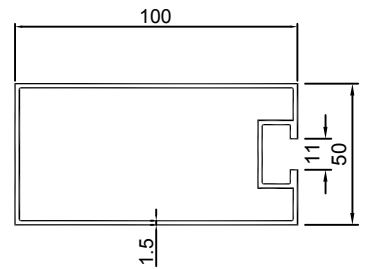

KU-204
1.36KG/M

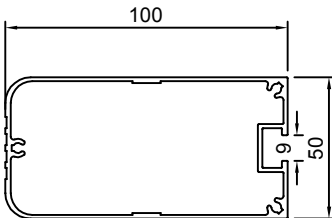

YN-HI 520
단중: 1.377 kg/m
외주위장: 322.9 mm

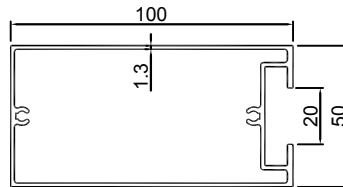

UR-185
?: 1.336kg/m
????: 348.5mm

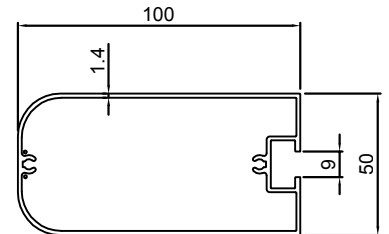

JH-HM001
?: 1.293kg/m
????: 322.8mm

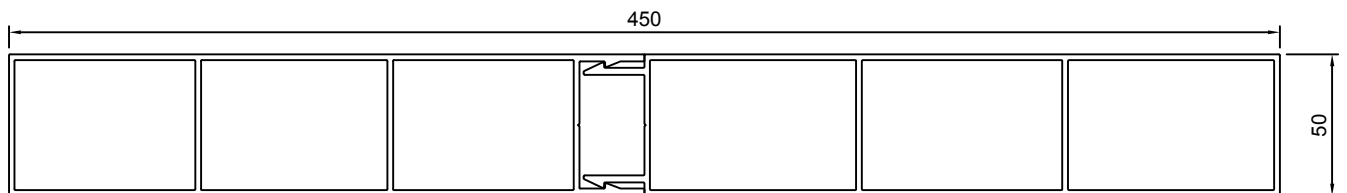

YN-KS068
단중: 3.530 kg/m
외주위장: 599.5 mm

YN-KS069
단중: 3.747 kg/m
외주위장: 637.4 mm

Basic Rectangular LOUVER Series

(基本長方形の形)- 기본 직사각형-내외장 벽, 천정

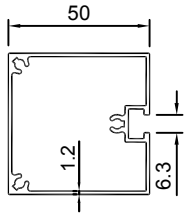

HI-112
0.848kg/m
221.9mm

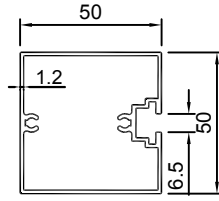

UR-167
?: 0.843kg/m
????: 232.9mm

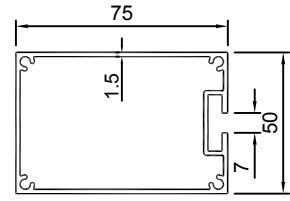

KU-130-1
1.21KG/M

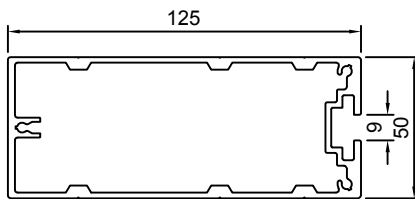

TKS-125
2.693kg/m
396.5mm

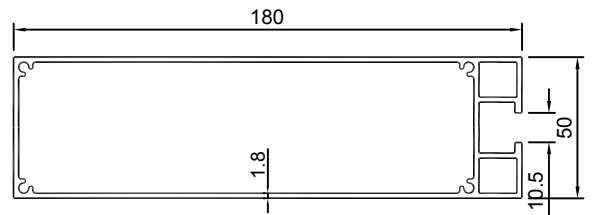

KU-209
2.638KG/M

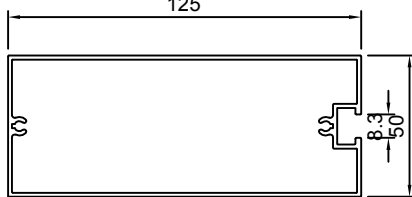

YN-HI297
단중: 1.489 kg/m
외주위장: 375.0 mm

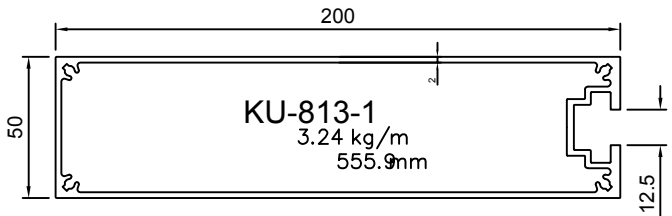

KU-813-1
3.24 kg/m
555.9mm

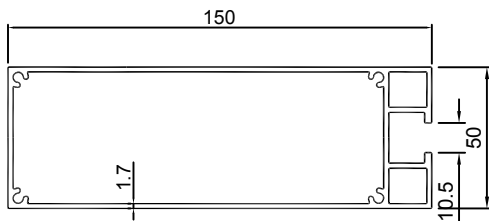

KU-097
2.255KG/M

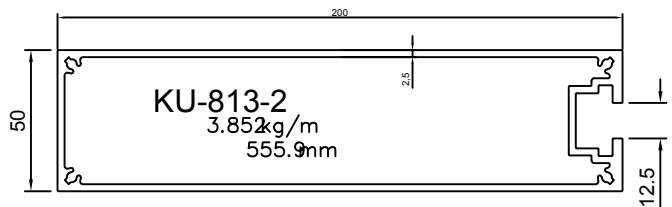

KU-813-2
3.852kg/m
555.9mm

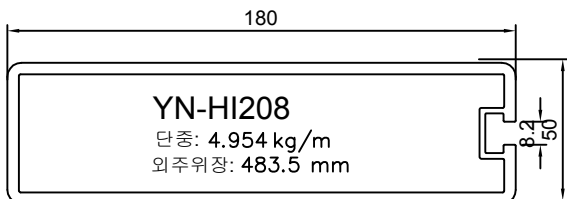

YN-HI208
단중: 4.954 kg/m
외주위장: 483.5 mm

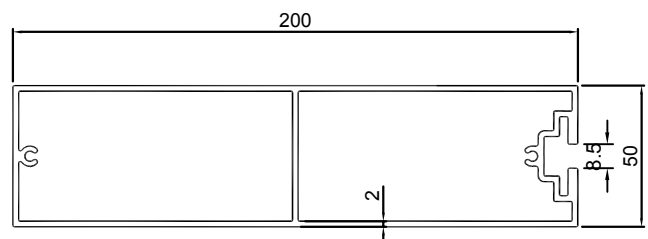

HM-001
3.34 kg/m
609.1mm

Basic Rectangular LOUVER Series

(基本長方形の形)- 기본 직사각형-내외장 벽, 천정

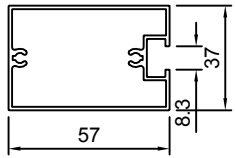

YN-HI513
단중: 0.763 kg/m
외주위장: - mm

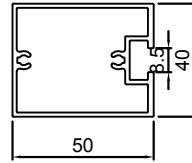

HM-045
단중: 0.925kg/m
외주위장: 206.5mm

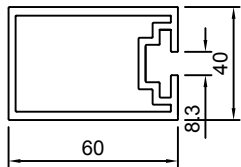

KU-1013
단중: 1.77 kg/m
외주위장: 193.3mm

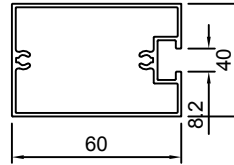

YN-HI308
단중: 0.874 kg/m
외주위장: 227.1 mm

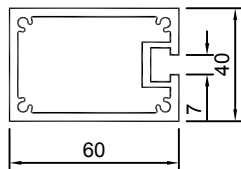

KU-166
1.78KG/M

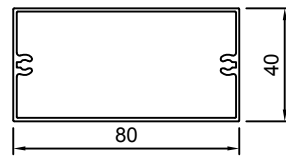

YN-KU222
단중: 0.882kg/m
외주위장: 239.5mm

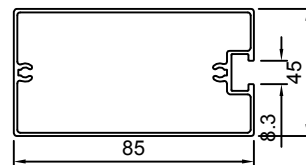

YN-HI285
단중: 1.013 kg/m
외주위장: 282.7 mm

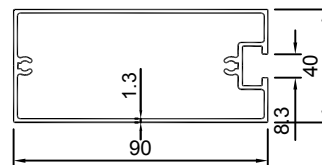

HI-117
1.094kg/m
287.9mm

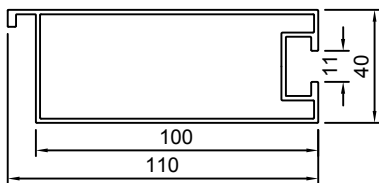

YN-KU543
단중: 1.352 kg/m
외주위장: 290.0mm

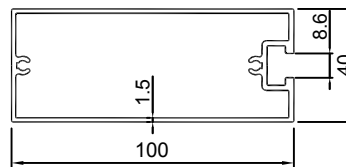

J-TS026
1.365kg/m
307.9mm

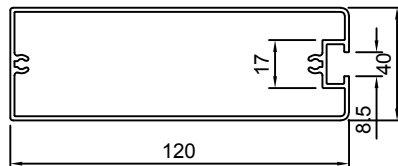

YN-HI244
단중: 1.448 kg/m
외주위장: 342.5 mm

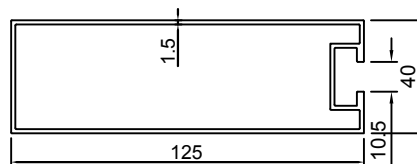

KU-535
1.465KG/M

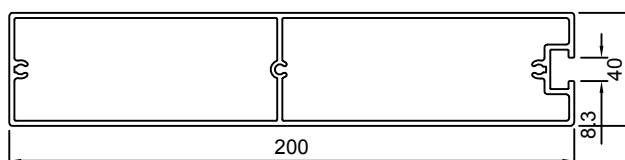

YN-HI299
단중: 2.700 kg/m
외주위장: 505.5 mm

Basic Rectangular LOUVER Series

(基本長方形の形)- 기본 직사각형-내외장 벽, 천정

mm

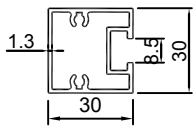

MSK-014(6"-1)
0.584kg/m
145.5mm

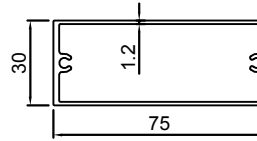

TKS-039
W/M: 0.804kg/m
C: 209.5mm

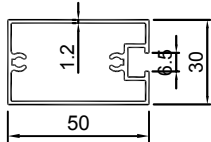

HI-116(6"-1)
0.666 kg/m
181.5 mm

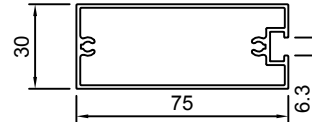

YN-HI395
단중: 0.881 kg/m
외주위장: 222.9 mm

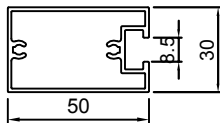

JH-HM003
0.732kg/m
186.5

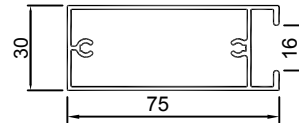

UR-029
???: 0.889kg/m
?????: 250.1mm

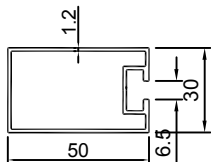

KU-303
0.598KG/M

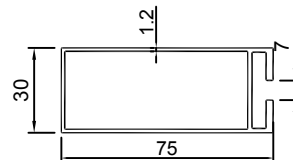

KU-339
0.834KG/M

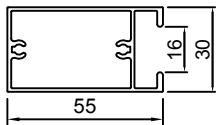

UR-134
0.734kg/m
210.1mm

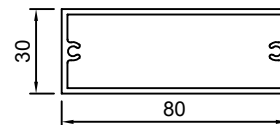

YN-HI 519
1.229 kg/m
외주위장: 220 mm

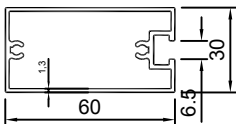

MR-025
0.800 kg/m
201.5 mm

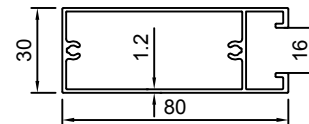

TKS-114
kg/m
281.94

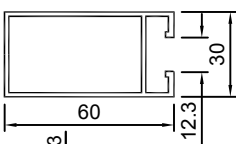

SKC-027
0.797kg/m
233.9mm

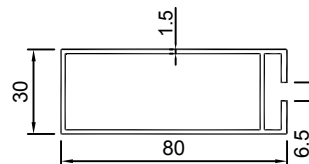

KU-275B
0.978KG/M

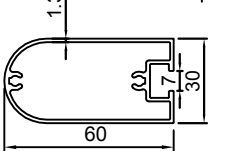

JH-HM002
kg/m
192.6

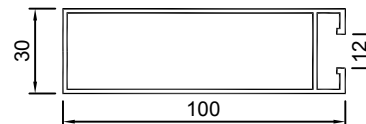

SKC-028
1.121kg/m
313.9

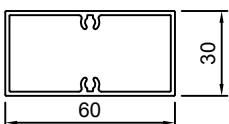

YN-HI367
단중: 0.774 kg/m
외주위장: 285.7 mm

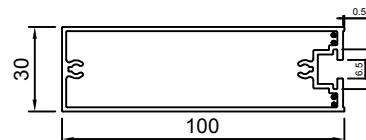

YN-M001
1.269 kg/m
302.06 mm

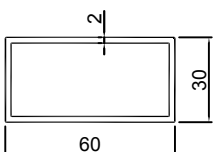

KU-036
0.932KG/M

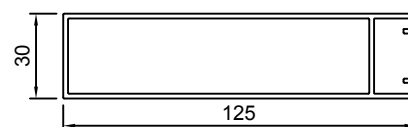

TKS-115
1.470kg/m
218.6

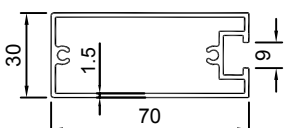

FJ-007
0.980 kg/m
225.9



YN-HI216A
단중: 1.728 kg/m
외주위장: 437.7 mm

Basic Rectangular LOUVER Series

(基本長方形の形)- 기본 직사각형-내외장 벽, 천정

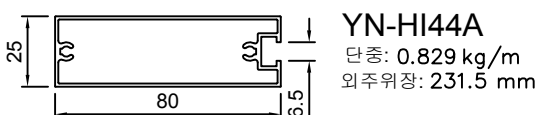
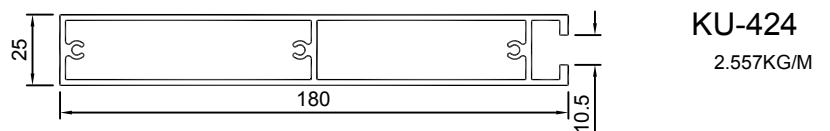
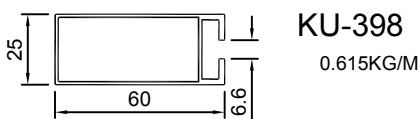
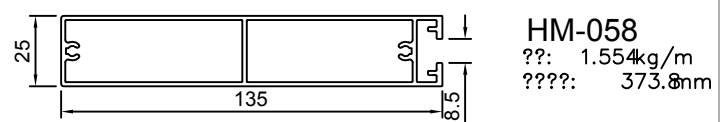
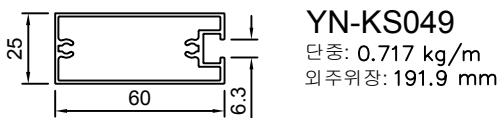
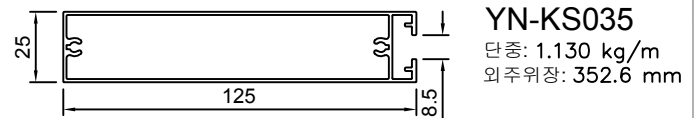
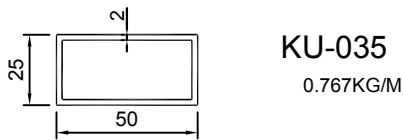
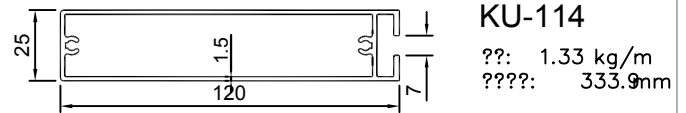
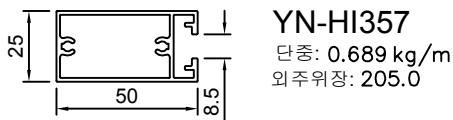
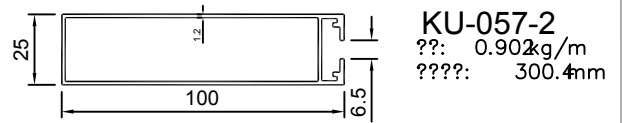
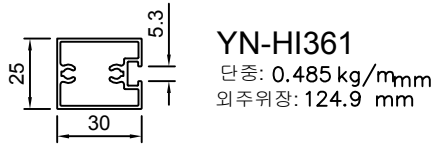
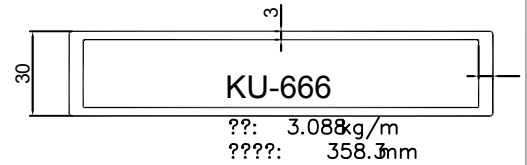
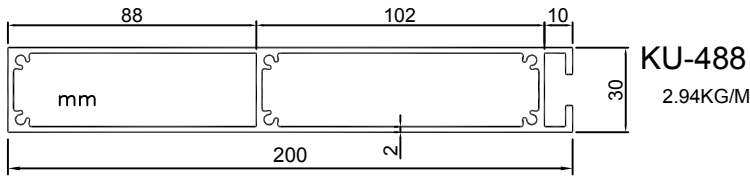
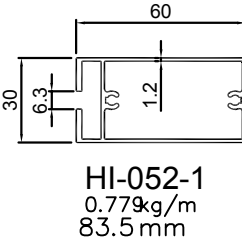
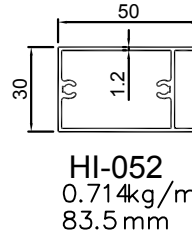
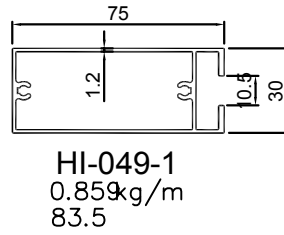
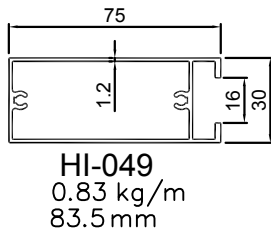
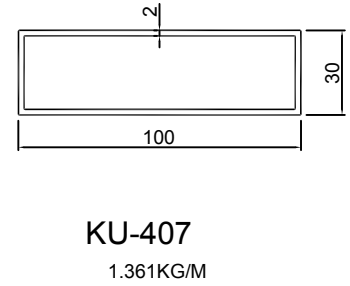
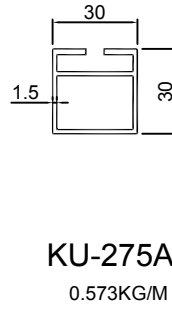
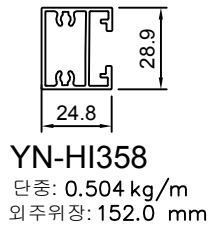
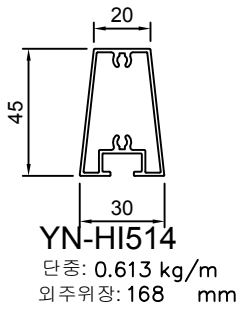

Basic Rectangular LOUVER Series

(基本長方形の形)- 기본 직사각형-내외장 벽, 천정

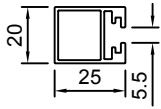

UR-069
??: 0.388kg/m
????: 133.9mm

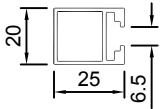

UR-025
??: 0.368kg/m
????: 121.9mm

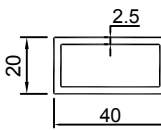

KU-367
0.745KG/M

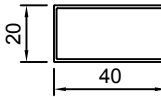

TKS-025
W/M: 0.314kg/m
C: 119.5mm

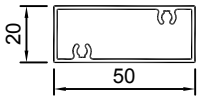

KU-765
??: 0.539kg/m
????: 139.5mm

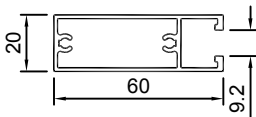

HI-046
0.698kg/m
83.5 mm

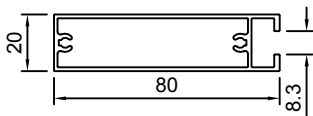

YN-HI349
단중: 0.833 kg/m
외주위장: 236.7 mm

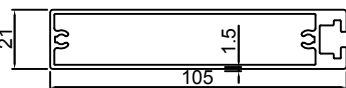

UR-093
??: 1.296kg/m
????: 283.7mm

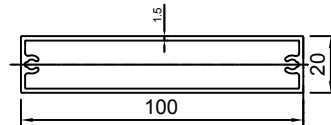

TKS-119
1.042kg/m
239.5mm

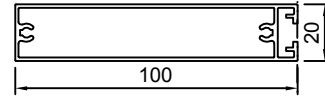

YN-HI301
단중: 0.922 kg/m
외주위장: 286.1 mm

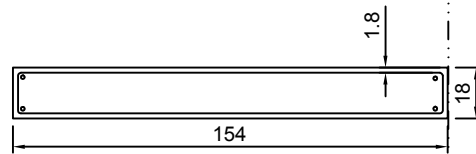

YN-PIP 15418
단중: 1.64 kg/m
외주위장: - mm

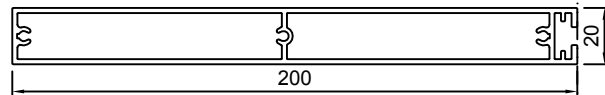

YN-HI307
단중: 2.372 kg/m
외주위장: 485.4 mm

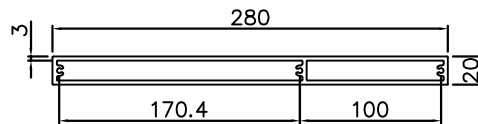

YN-HI081
단중: 5.055 kg/m
외주위장: 599.2 mm

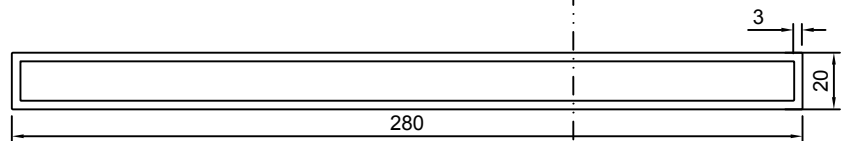

YN-KS 092
단중: 4.763 kg/m
외주위장: 599.5 mm

Basic Rectangular LOUVER Series

(基本長方形の形)- 기본 직사각형-내외장 벽, 천정

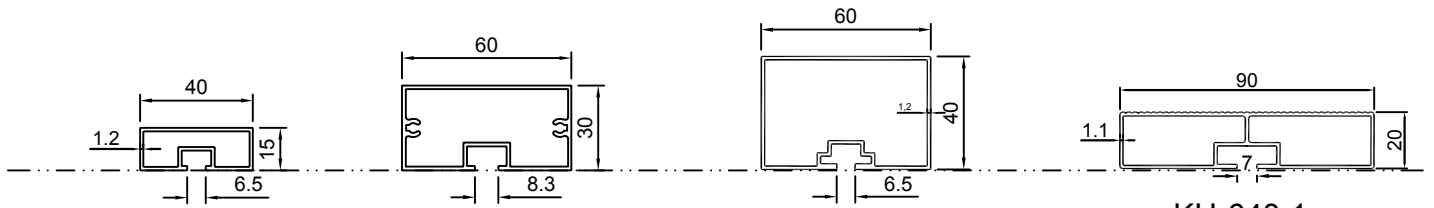

HI-084-2
0.404kg/m

YN-HI 515
단중: 0.789 kg/m

KU-846
??: 0.756kg/m

KU-648-1
??: 0.828kg/m
????: 267.8mm

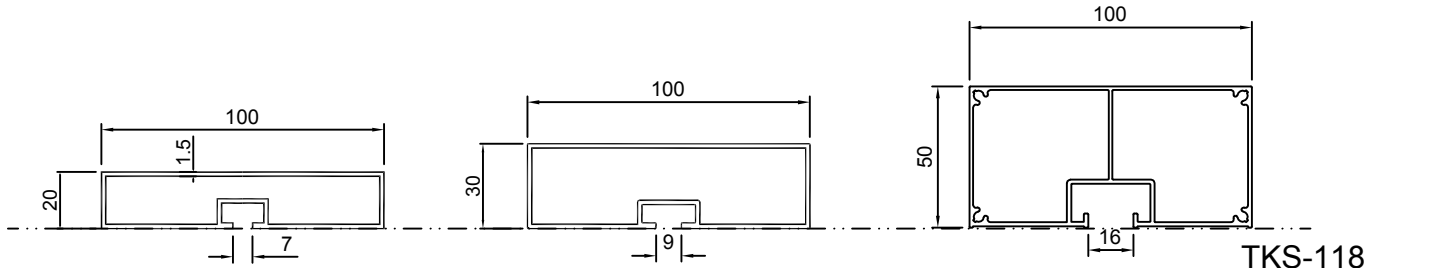

KU-137
1.064KG/M

KU-366-1
??: 1.155kg/m
????: 295.5mm

TKS-118
1.486kg/m
367.5mm

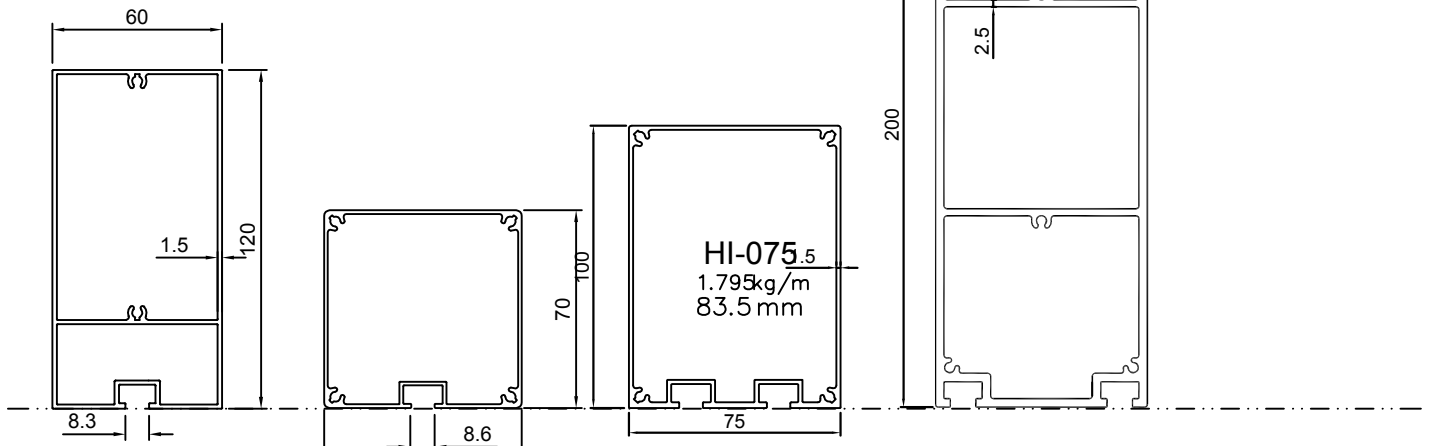

YN-HI509
단중: 1.856
외주위장:

YN-KS077
단중: 1.221 kg/m
외주위장: 302.9 mm

HI-075.5
1.795kg/m
83.5 mm

JH-ASB058-3
??: 5.750kg/m
????: 600.2mm

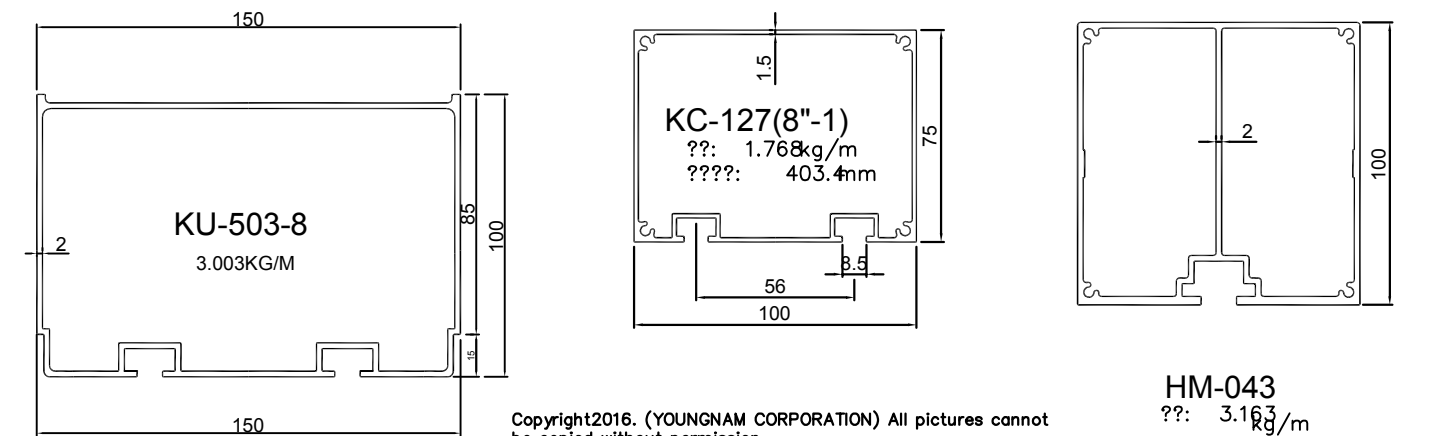

KU-503-8
3.003KG/M

KC-127(8"-1)
??: 1.768kg/m
????: 403.4mm

HM-043
??: 3.163 kg/m
????: 455.3mm

Basic Rectangular LOUVER Series

(基本長方形の形)- 기본 직사각형-내외장 벽, 천정

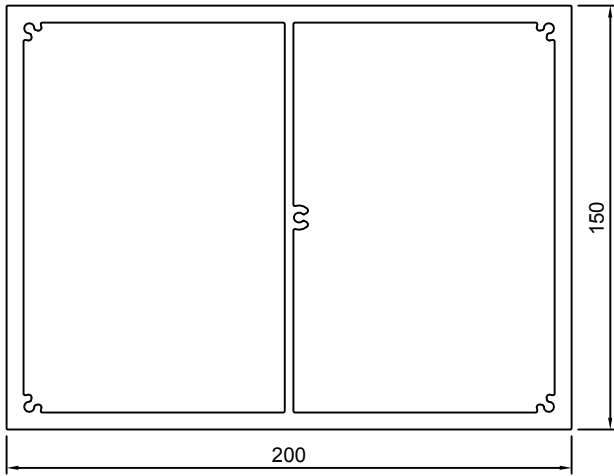

YN-HI 518

단중: 12.36kg/m
외주위장: 294.5 mm

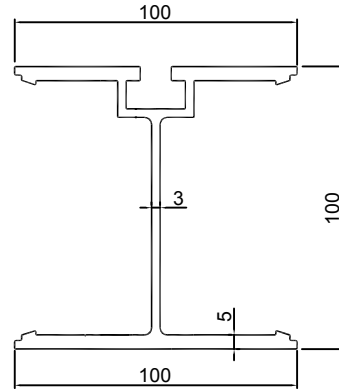

KU-489

3.554 Kg/m

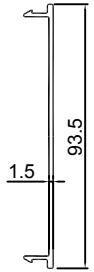

KU-489A

0.451KG/M

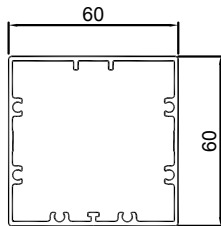

YN-026

1.170 kg/m
238.3 mm

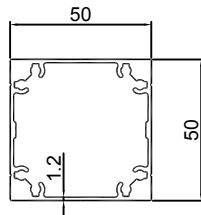

KU-213

1.268KG/M

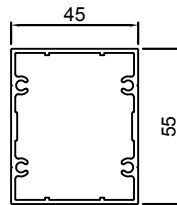

YN-UB002

0.992
200.5

Basic Rectangular LOUVER Series

(基本長方形の形)- 기본 직사각형-내외장 벽, 천정

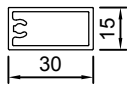

YN-HI364
단중: 0.387 kg/m
외주위장: 89.5 mm

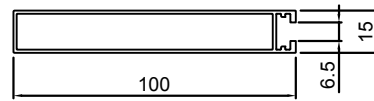

YN-KU077
단중: 0.720 kg/m
외주위장: 258.6mm

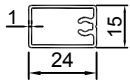

KU-214
0.245KG/M

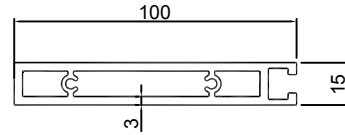

KU-381-1
1.878KG/M

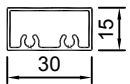

TKS-060
0.314kg/m
89.5 mm

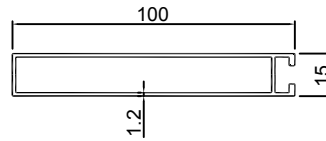

KU-451
???: 0.765kg/m
?????: 254.7mm

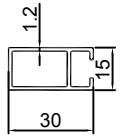

KU-206-1
0.298KG/M

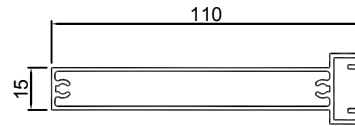

UR-150
???: 1.109kg/m
?????: 325.9mm

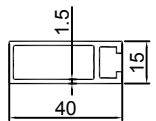

KU-205-1
0.485KG/M

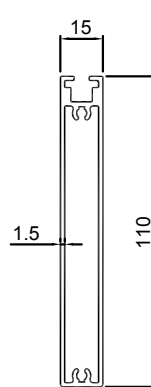

HM-023
???: 1.169kg/m
?????: 278.5mm

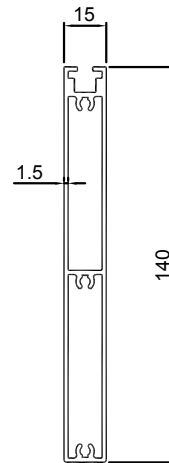

HM-024
???: 1.508kg/m
?????: 338.5mm

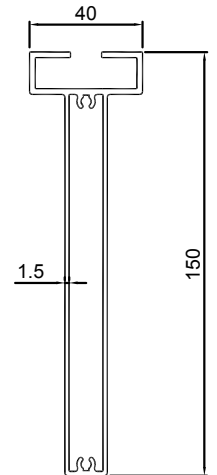

HM-025
???: 1.730kg/m
?????: 452.1mm

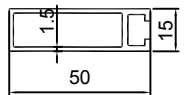

KU-205
0.566KG/M

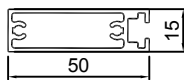

IY-012
???: 0.602kg/m
?????: 156.7mm

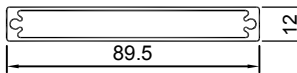

KU-451-1
???: 0.766kg/m
?????: 201.3mm

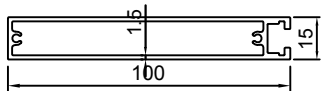

KC-129
???: 1.01 kg/m
?????: 257.0mm

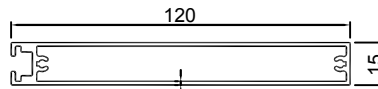

UR-183
???: 1.081kg/m
?????: 296.9mm

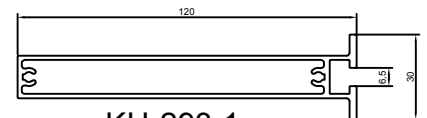

KU-293-1
???: 1.316kg/m
?????: 327.3mm

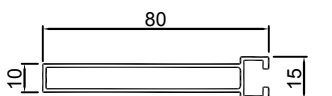

SKC-026
???: 0.618kg/m
?????: 217.7mm

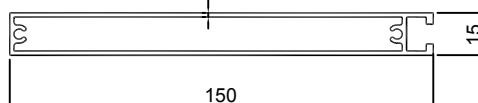

KU-217
1.428KG/M

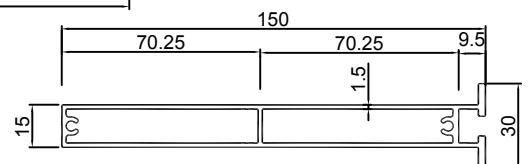

KU-429
1.587KG/M